

GASO.LINE

Nomenclature GASSPE12 EFA Waterline

N°	Désignation	Qt
1	Pont central	1
2	Caisse central	2
3	Flotteur dessous pont 2	2
4	Flotteur central	2
5	Flotteur extérieur G	2
6	Flotteur extérieur D	2
7	Passerelle AVD	1
8	Passerelle central D	1
9	Passerelle ARD et AVG	2
10	Passerelle ARG	1
11	Passerelle pont 3 D+G	2+2
12	Passerelle ext pont 3 D+G	2+2
13	Passerelle central G	1
14	Caisse bâchée	1
15	Caisse ouverte	1
16	Caisse fermée	1
17	Pont 2	2
18	Pont 3	2
19	Cabine AV	1
20	Cabine AR	1
21	Pupitre	1
22	Grille pont 3	2
23	Grille pont 2	2
24	Plaque protection	2
25	Ancre	2
26	Axe charnière pont 3	2
27	Axe charnière pont 2	2
28	Charnière vérin D + G	2+2
29	Vérin	2
30	Vérin pont	4
31	Passerelle cabine D + G	2+2
32	Rétroviseur	3
33	Photodécoupe	1

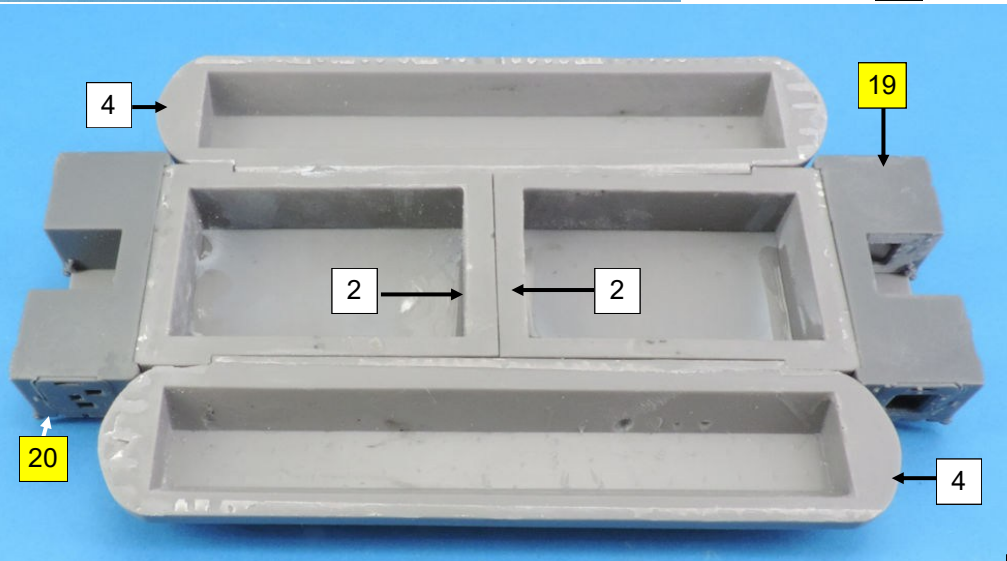
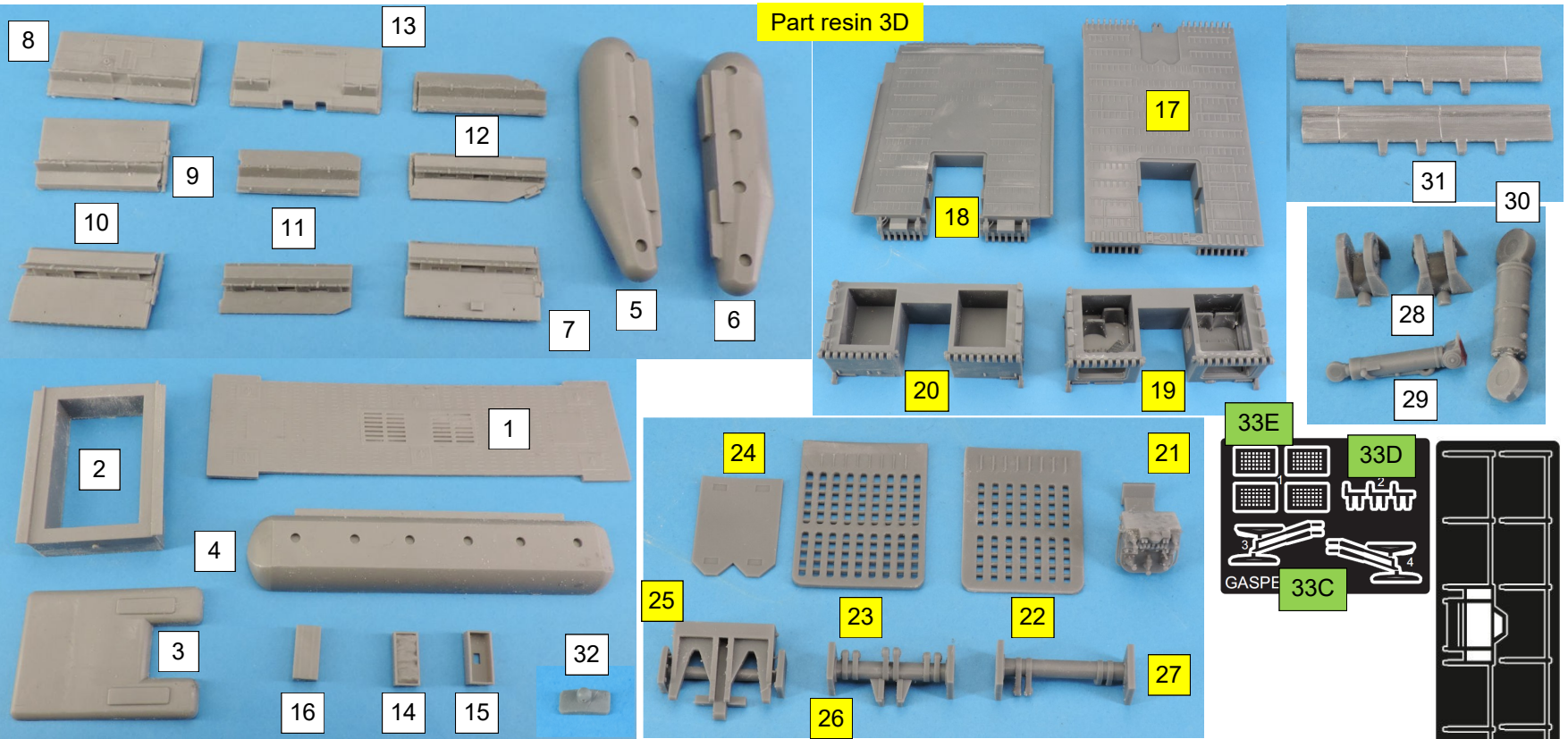

A couper / To cut

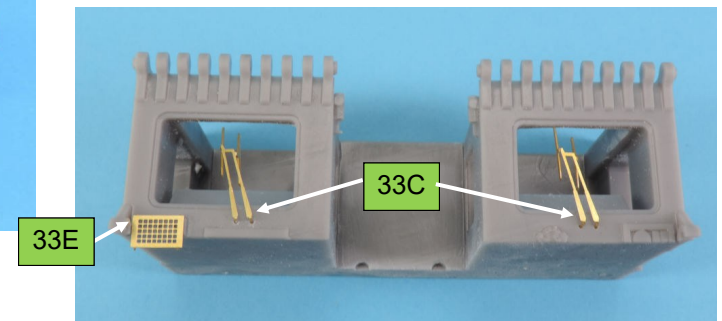

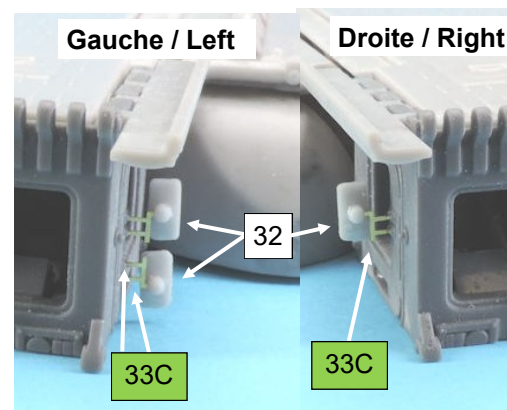
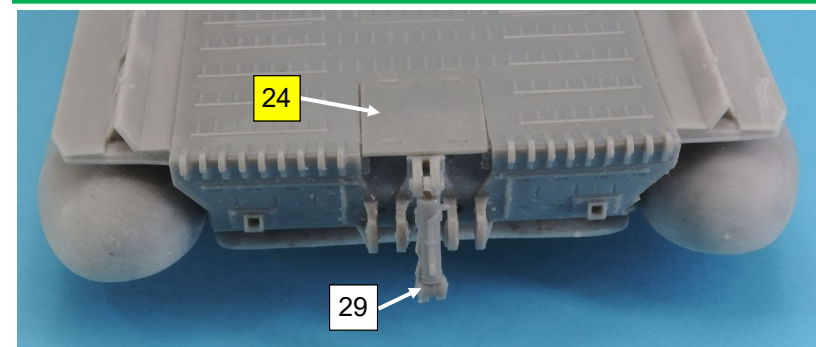
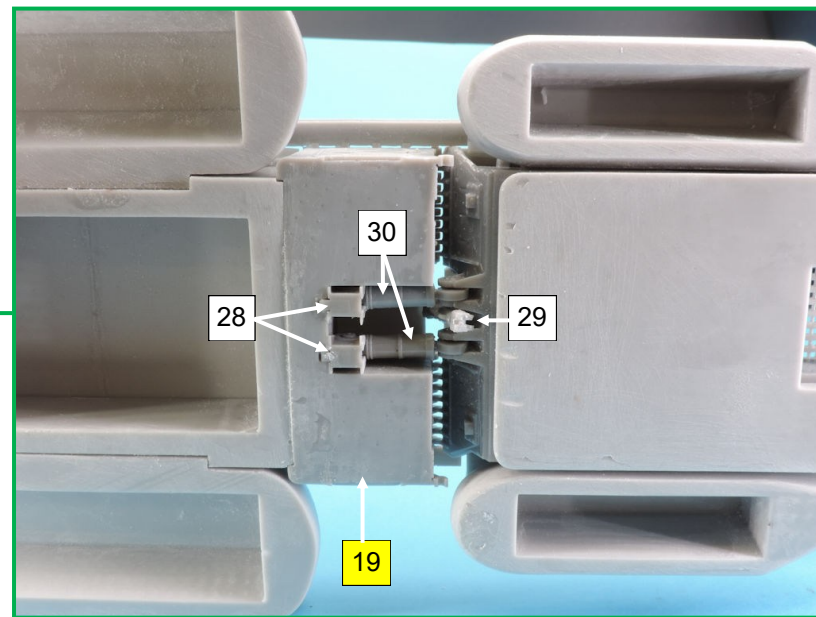
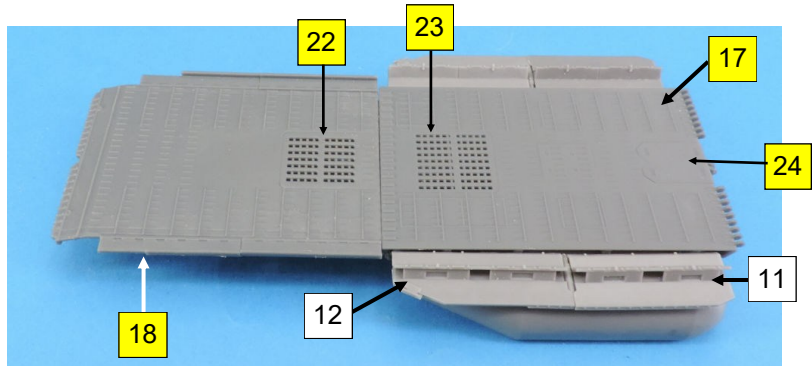
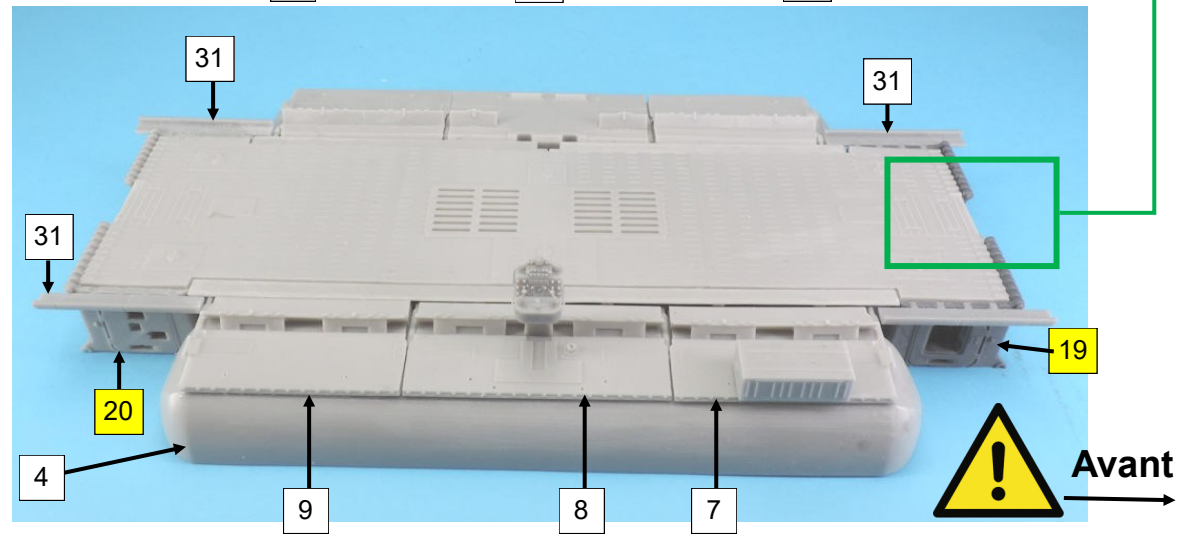
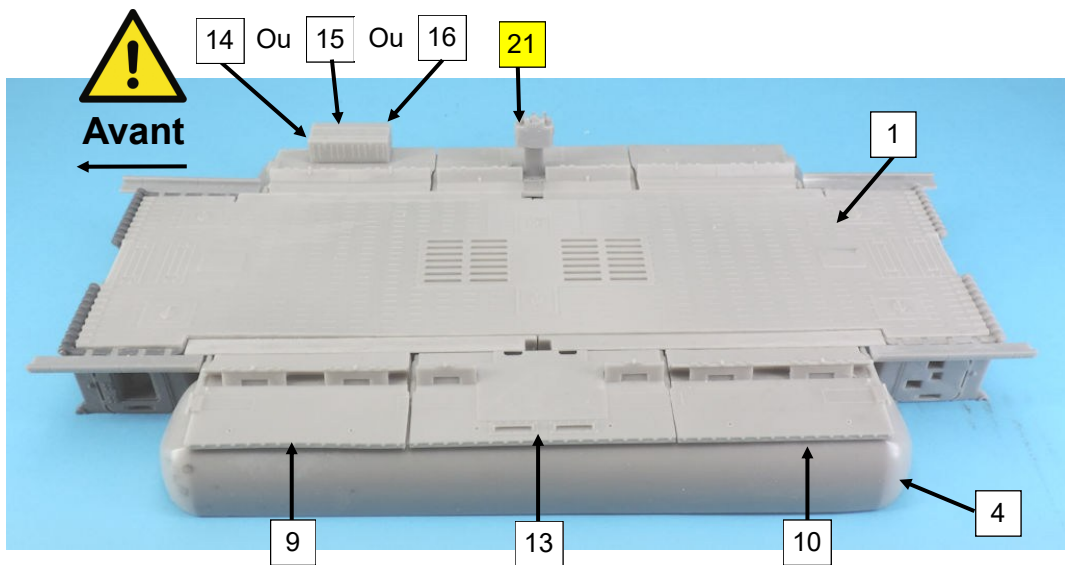

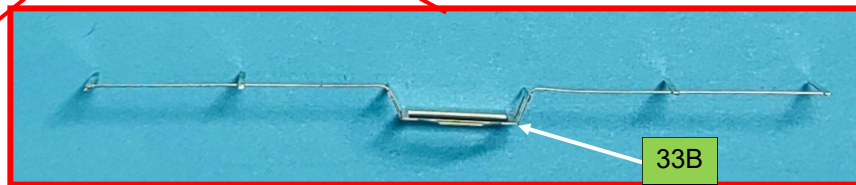
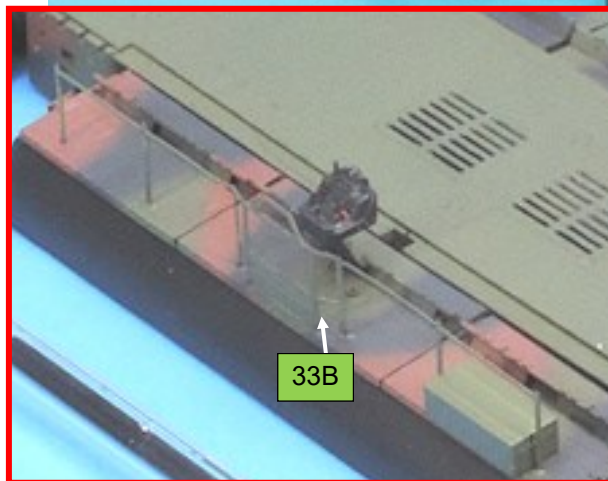
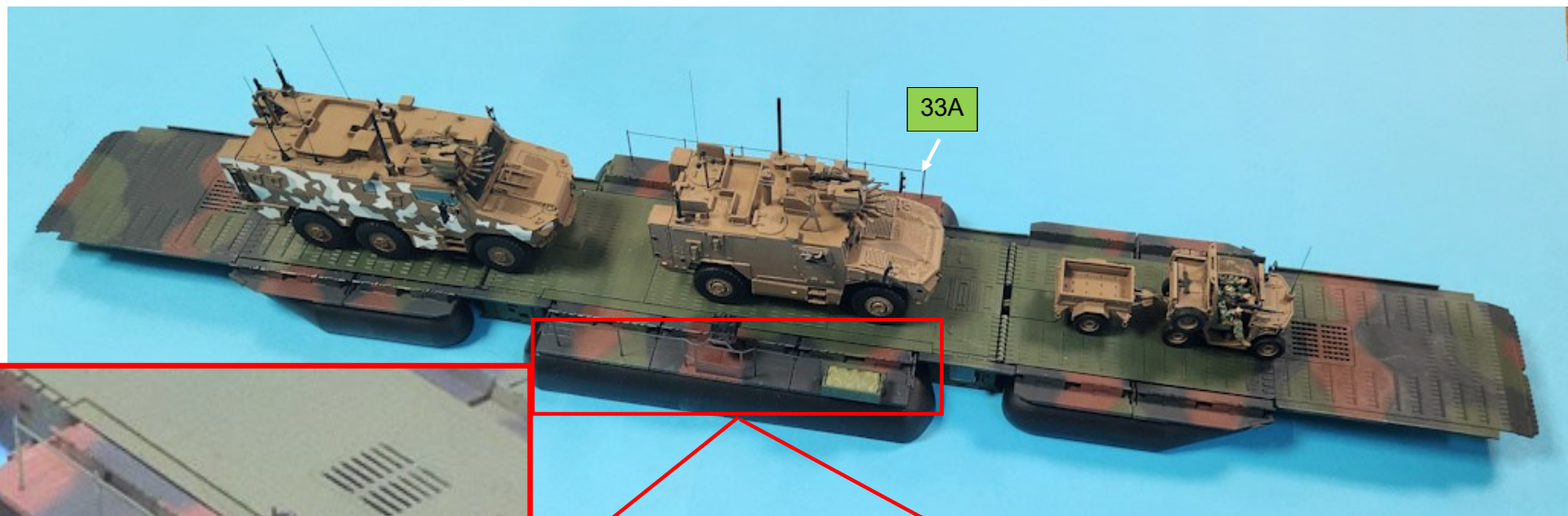
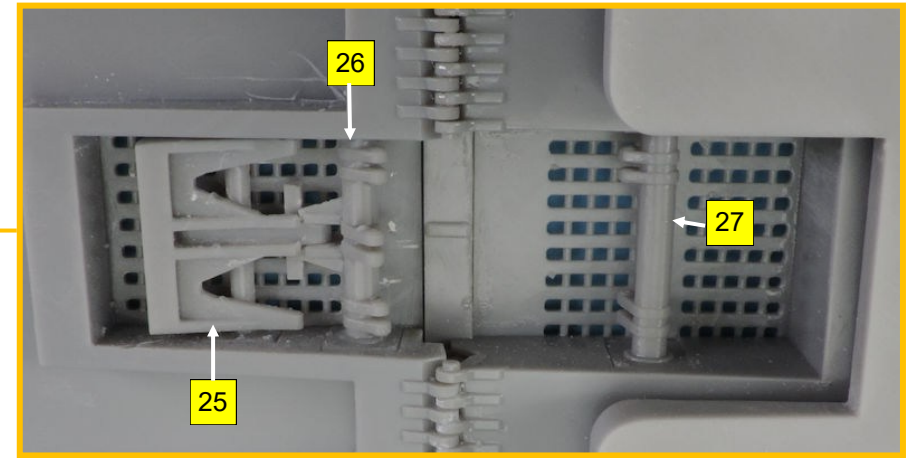
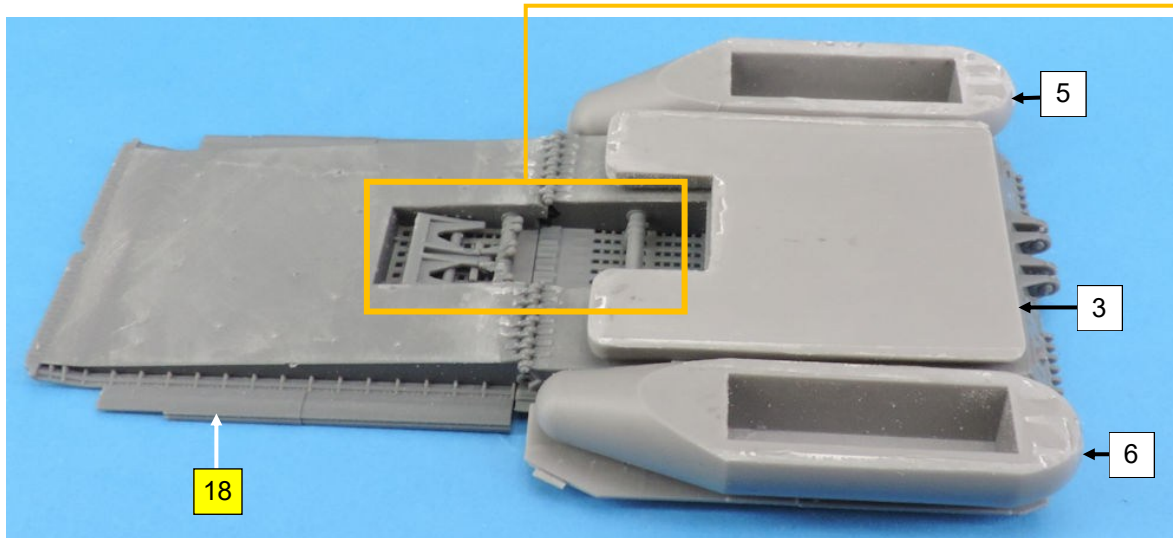

Ce modèle est fabriqué par **Gaso.line** pour **Quarter Kit**
 10, passage du charolais 75012 Paris Tél./Phone: (33) 01.44.75.01.61
 E-mail: info@quarter-kit.com / web site: www.promodels.eu

